



bryton®



# Rider 310

User's Manual



## Table of Contents

<b>Getting Started</b> .....	<b>4</b>	<b>Set Alert</b> .....	<b>19</b>
Your Rider 310 .....	4	<b>Smart Pause</b> .....	19
Accessories .....	5	<b>Data Record</b> .....	20
Status Icons .....	5	<b>Personalize User Profile</b> .....	21
Step 1: Charge your Rider 310 ...	6	<b>Personalize Bike Profile</b> .....	22
Step 2: Turn On Rider 310 .....	6	<b>Change System Settings</b> .....	23
Step 3: Initial Setup.....	6	<b>View GPS Status</b> .....	25
Step 4: Acquire Satellite Signals.....	7	<b>View Software Version</b> .....	26
Step 5: Ride Your Bike with Rider 310.....	7	<b>Bluetooth</b> .....	26
Reset Rider 310 .....	7	<b>Configure Acto Scroll</b> .....	27
Share Your Records .....	8	<b>Enable File Saving Mode</b> .....	27
<b>Training</b> .....	<b>9</b>	<b>Start Reminder</b> .....	28
Simple Workouts .....	9	<b>View Memory Usage</b> .....	28
Interval Workouts .....	10	<b>Reset Data</b> .....	29
My Workout .....	12	<b>Sensors</b> .....	30
Bryton Test .....	12	<b>Appendix</b> .....	<b>31</b>
Stop Training .....	13	Specifications .....	31
View Exercise/Training Record .....	13	Battery Information .....	32
History Flow.....	14	Install Rider 310 .....	33
<b>Settings</b> .....	<b>15</b>	Install the Speed/Cadence/ Dual Sensor (Optional) .....	34
Smart Lap.....	15	Install Heart Rate Belt (Optional).....	35
Altitude .....	16	Wheel Size and Circumference .....	36
Data Page .....	17	Basic Care For Your Rider 310...	37
		Data Fields .....	38



## WARNING

Always consult your physician before you begin or modify any training program. Please read the details in Warranty and Safety Information guide in the package.

## Product Registration

Help us better support you by completing your device registration using Bryton Update Tool. Go to <http://corp.brytonsport.com/products/support>.

## Bryton Software

Go to <http://brytonsport.com> to upload tracks and analyze your data on the web.

## Australian Consumer Law

Our goods come with guarantees that can not be excluded under the New Zealand and Australian Consumer Laws. You are entitled to a replacement or refund for a major failure and for compensation for any other reasonably foreseeable loss or damage. You are also entitled to have the goods repaired or replaced if the goods fail to be of acceptable quality and the failure does not amount to a major failure.

# Getting Started

This section will guide you on the basic preparations before you start using your Rider 310. Rider 310 is equipped with barometer which shows the real time altitude.

**NOTE:** To adjust the altitude settings on Rider 310, refer to page 16.

## Your Rider 310



### 1 BACK (■/||)

- Press and hold to turn the device off.
- Press to return to the previous page or cancel an operation.
- When recording, press to pause recording. Press it again to stop recording.

### 2 LAP/OK (●)

- Press to turn the device on.
- In Menu, press to enter or confirm a selection.
- In free cycling, press to start recording.
- When recording, press to mark the lap.

### 3 PAGE (▼)

- In Menu, press to move down to scroll through menu options.
- In Meter view, press to switch meter screen page.

# Accessories









The Rider 310 comes with the following accessories:









- USB cable
- Bike mount

*Optional items:*

- Heart rate belt
- Speed sensor
- Cadence sensor
- Speed/Cadence Dual sensor
- Out-front Bike Mount

# Status Icons

Icon	Description
<b>Bike Type</b>	
	Bike 1
	Bike 2
<b>GPS Signal Status</b>	
	No signal (not fixed)
	Weak signal
	Strong signal
<b>Power Status</b>	
	Full battery
	Half battery
	Low battery

Icon	Description
	Heart Rate Sensor Active
	Cadence Sensor Active
	Speed Sensor Active
	Dual Sensor Active
	Notification
	Log Record in Progress
	Recording is paused
	Bluetooth function is enabled

**NOTE:** Only the active icons are displayed on the screen.  
Some icons may only apply to certain models

## Step 1: Charge your Rider 310

Connect Rider 310 to a PC to charge the battery for at least 4 hours. Unplug the device when it is fully charged.

- You may see a white screen when the battery is really low. Keep the device plugged for several minutes, it will automatically turn-on after battery is properly charged.
- The temperature suitable for charging battery is 0°C ~ 40°C. Beyond this temperature range, charging will be terminated and the device will draw power from battery.

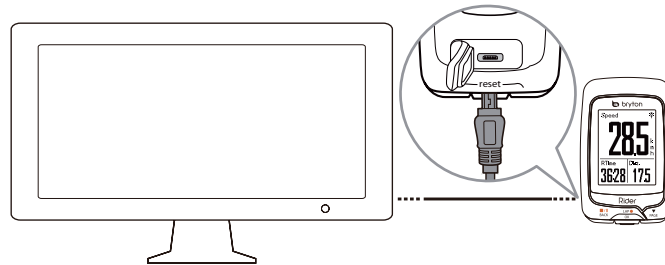

## Step 2: Turn On Rider 310

Press  $\overset{\text{LAP}}{\underset{\text{OK}}{\bullet}}$  to turn on the device.

## Step 3: Initial Setup

When turning Rider 310 on for the first time, the setup wizard appears on screen. Follow the instructions to complete setup.

1. Select the display language.
2. Select the unit of measurement.



**NOTE:** Only when you choose English for the display language, you will need to select the unit of measurement. Otherwise, default would be metric unit.

## Step 4: Acquire Satellite Signals

Once the Rider 310 is turned on, it will automatically search for satellite signals. It may take 30 to 60 seconds to acquire signals. Please make sure you acquire the satellite signal for the first time use.

The GPS signal icon (📶/📶) appears when GPS is fixed.

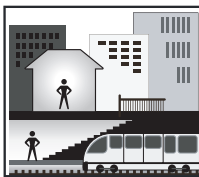
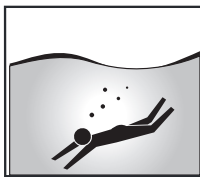
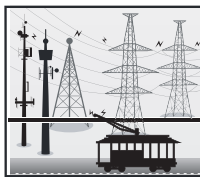
- If the GPS signal is not fixed, an 📶<sup>x</sup> icon appears on the screen.
- Please avoid the obstructed environments since they might affect the GPS reception.



				
Tunnels	Inside rooms, building, or underground	Under water	High-voltage wires or television towers	Construction sites and heavy traffic

## Step 5: Ride Your Bike with Rider 310

- **Free ride:**

In meter view, measurement starts and stops automatically in sync with the movement of the bicycle.

- **Start an exercise and record your data:**

In meter view, press  to start recording, press  to pause, press  again to stop.

- **Start a training:**

Select **Train** from the menu list. Training can be based on time, distance, calories burn, or the saved workouts.

## Reset Rider 310

To reset the Rider 310, long press all three keys (  /  /  ) at the same time.



## Download Bryton Update Tool

**NOTE:** Bryton Update Tool can notify you if a new software version or GPS data is available. The newer GPS data can speed up the GPS acquisition. We highly recommend you to check for updates every 1-2 weeks.

1. Go to <http://www.brytonsport.com/help/start> and download Bryton Update Tool .
2. Follow the on-screen instructions to install Bryton Update Tool.

## Share Your Records

### Share Your Tracks to Brytonsport.com

1. Sign up/log in on Brytonsport.com
  - a. Go to <http://www.brytonsport.com/help/start>.
  - b. Register a new account or use your current Bryton account to log in.

**NOTE:** Bryton account is the email address used to register as a member of [brytonsport.com](http://www.brytonsport.com)

### 2. Connect to PC

Turn on your Rider 310 and connect it to your computer by using USB cable.

### 3. Share Your Records

- a. Go to <http://www.brytonsport.com/help/landing>. Click "Upload Files" button. Then, click "Select from Files".
- b. Choose to save as "History". Then, click "Select and Upload files".
- c. Select FIT files from Bryton folder in the device.



# Train & Test

Bicycling is one of the best types of exercise for your body. It helps you to burn your calories, lose weight, and increase your overall fitness. With the Rider 310 Training feature, you can set simple/interval workouts and use the Rider 310 to track your training or workout progress.

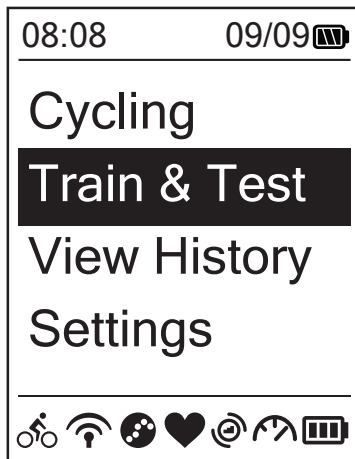

1. In the main screen, press  $\blacktriangledown$  PAGE to select **Train&Test**.
2. Press  $\bullet$  LAP /  $\bullet$  OK to enter the Training menu.

## To Plan

You can set simple workouts by entering your time or distance goals.

The Rider 310 offers you three types of simple workouts: Time, Distance, and Calories.

### Simple

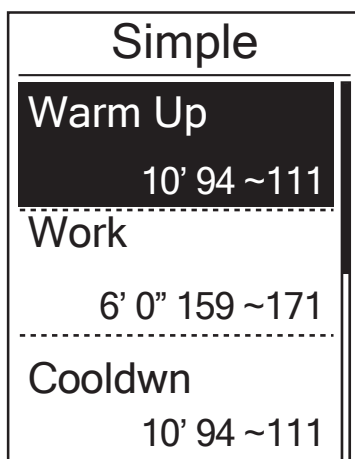

1. To set a simple workout, select **To Plan > Simple > Warm Up, Work , Cooldown**.
  - **Warm Up:**  
Duration (manual, calorie,time, distance), Target (Pace, HR, MHR, LTHR).
  - **Work:**  
Duration (calorie, time,distance), Target (Pace, MHR%, LTHR%, HR, MHR, LTHR, Off).
  - **Cooldown:**  
Duration (manual, calorie,time, distance), Target (HR, MHR, LTHR).
2. Press  $\blacksquare$  /  $\parallel$  /  $\blacktriangledown$  BACK / PAGE to set your target and press  $\bullet$  LAP /  $\bullet$  OK to confirm.
3. Choose **Save** and enter the workout name using the on-screen keyboard.
4. Go for a ride.  
Go to **Train & Test > My Workouts > View** and choose the saved workout. Press  $\bullet$  LAP /  $\bullet$  OK to start training and record log.

## Using the On-screen Keyboard

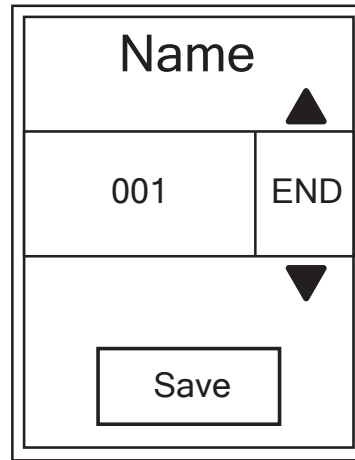
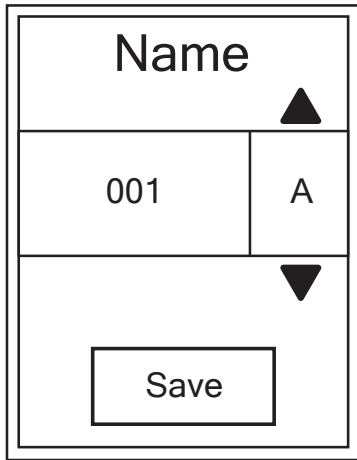

1. Press  $\blacksquare/\parallel/\blacktriangledown$  BACK / PAGE to select the input character.
  - Select **DEL** to erase the data.
2. Press  $\text{LAP} \bullet$  OK to confirm the selection.
3. When finished, press  $\blacksquare/\parallel/\blacktriangledown$  BACK / PAGE to select **END** and press  $\text{LAP} \bullet$  OK to confirm.

**NOTE:** If user does not enter the workout name, the system will automatically label the file name according to the current date and time.

## Interval Workouts

With the Interval training feature, you can use your device to customize interval workouts which include the warm up, interval, and cool down sections.

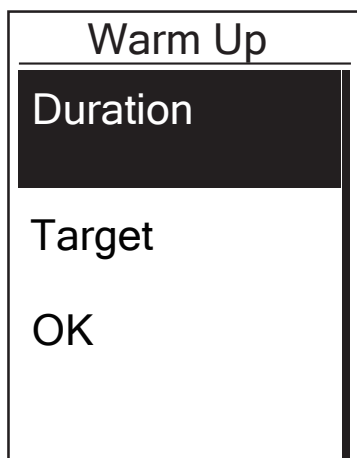

1. In the **Train & Test** menu, press  $\blacktriangledown$  PAGE to select **To Plan > Interval** and press  $\text{LAP} \bullet$  OK to enter.
2. A "Set warm up?" message appears on the screen. Press  $\blacktriangledown$  PAGE to select **Yes** to set the "Warm up". After the settings are complete, select **OK** and press  $\text{LAP} \bullet$  OK to continue.

Work 1	
<b>Work</b>	
6'00"	158~170bpm
<b>Recovery</b>	
2'00"	137~149bpm
<b>Repeat Time</b>	
2	

Cooldown	
<b>Duration</b>	
Target	
OK	

- Set the interval workout settings (Work, Recovery, and Repeat Time). When finished, press  $\blacktriangledown$  PAGE to select **Next** and press  $\overset{\text{LAP}}{\bullet}$  OK.
- A "Create a new main set?" message appears on the screen. To create another set of interval workout, select **Yes** and press  $\overset{\text{LAP}}{\bullet}$  OK to confirm.
- A "Set cool down?" message appears on the screen. Select **Yes** to set the "Cool down". After the settings are complete, select **OK** and press  $\overset{\text{LAP}}{\bullet}$  OK to continue.
- A "Save to My Workout" message appears on the screen. Select **Yes** and press  $\overset{\text{LAP}}{\bullet}$  OK to continue. Press  $\blacksquare$  /  $\parallel$  /  $\blacktriangledown$  BACK / PAGE to enter the workout name. When finishing the name, press  $\blacksquare$  /  $\parallel$  BACK and press  $\overset{\text{LAP}}{\bullet}$  OK to save the workout.

# My Workout

With My Workout feature, you can start your workout using the training plan that you have saved in **To Plan** menu.

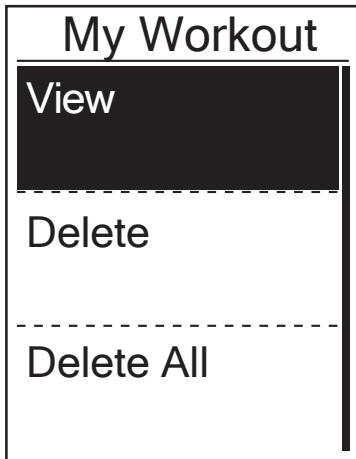

1. In the Training menu, press  $\blacktriangledown$  <sub>PAGE</sub> to select **My Workout** and press  $\bullet$  <sub>LAP</sub>  $\bullet$  <sub>OK</sub>.
2. Press  $\blacktriangledown$  <sub>PAGE</sub> to select **View** and press  $\bullet$  <sub>LAP</sub>  $\bullet$  <sub>OK</sub> to enter its submenu.
  - Press  $\blacktriangledown$  <sub>PAGE</sub> to select your desired training plan and press  $\bullet$  <sub>LAP</sub>  $\bullet$  <sub>OK</sub> to confirm.
  - Go for a ride. Press  $\bullet$  <sub>LAP</sub>  $\bullet$  <sub>OK</sub> to start training and record log.
3. To choose which workouts to delete, select **Delete**.
4. To delete all workouts to delete, select **Delete All**.

**NOTE:** If the selected workout includes several interval settings, a workout details appear on the screen. Select **Start** and press  $\bullet$  <sub>LAP</sub>  $\bullet$  <sub>OK</sub> to proceed with the workout.

# Bryton Test

Bryton Test has preloaded on Rider 310. If you don't have it on your device, please download from Bryton Update Tool. Bryton Test includes two test courses to help you measuring your MHR and/or LTHR. Knowing your MHR and/or LTHR gives you a benchmark of your overall efficiency. It also helps you to judge progress over time and measure your exercise intensity.

1. In the main screen, press  $\blacktriangledown$  <sub>PAGE</sub> to select **Train & Test** and press  $\bullet$  <sub>LAP</sub>  $\bullet$  <sub>OK</sub> to enter Training menu.
2. Press  $\blacktriangledown$  <sub>PAGE</sub> to select **Bryton Test** and press  $\bullet$  <sub>LAP</sub>  $\bullet$  <sub>OK</sub> to enter Bryton Test.
3. Press  $\blacktriangledown$  <sub>PAGE</sub> to select your desired test workout and press  $\bullet$  <sub>LAP</sub>  $\bullet$  <sub>OK</sub> to enter the selected workout.
4. The selected workout details appear on the screen. Press  $\bullet$  <sub>LAP</sub>  $\bullet$  <sub>OK</sub> to start exercise.
5. When finished the Bryton Test, press  $\blacksquare$  /  $\parallel$  <sub>BACK</sub> and  $\bullet$  <sub>LAP</sub>  $\bullet$  <sub>OK</sub> to save the result.

## Stop Training

You can stop the current training after you have reached your goal or when you decide to end the current training.

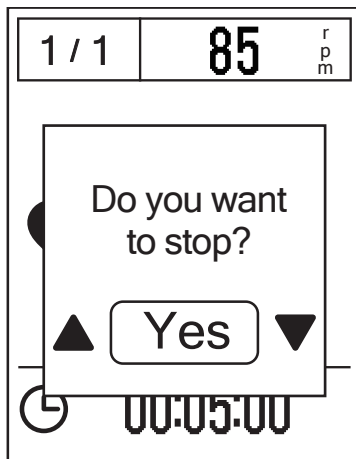

1. Press  $\blacksquare/\parallel$  <sub>BACK</sub> to pause the recording and press  $\blacksquare/\parallel$  <sub>BACK</sub> again to stop the recording.
2. A “Do you want to stop?” message appears on the screen. To stop the current training, press  $\blacksquare/\parallel/\blacktriangledown$  <sub>BACK/PAGE</sub> to select **Yes** and press  $\bullet$  <sub>LAP/OK</sub> to confirm.

## View Exercise/Training Record

Use View History to view or delete your exercise/training history.

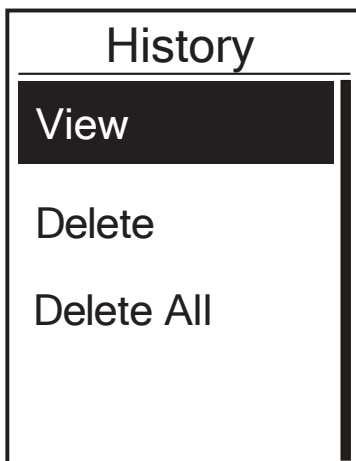

To view your history:

1. In the main screen, press  $\blacktriangledown$  <sub>PAGE</sub> to select **View History** > **View** and press  $\bullet$  <sub>LAP/OK</sub>.
2. Press  $\blacktriangledown$  <sub>PAGE</sub> to select **View** and press  $\bullet$  <sub>LAP/OK</sub> to confirm.
3. Press  $\blacktriangledown$  <sub>PAGE</sub> to select a training history from the list and press  $\bullet$  <sub>LAP/OK</sub> to view your history.

**NOTE:** You can also upload your history to [brytonsport.com](http://brytonsport.com) to keep track of all your ride data.

## Delete History

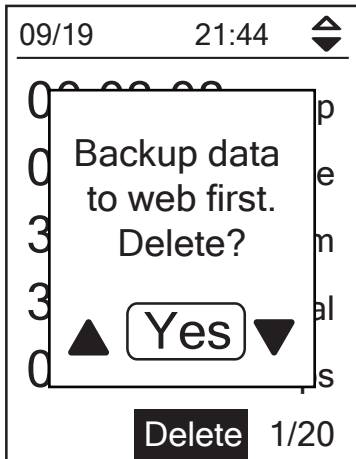

To delete your history:

1. In the main screen, press  $\blacktriangledown$  <sub>PAGE</sub> to select **View History** > **View** and press  $\bullet$  <sub>LAP OK</sub>.
2. Press  $\blacktriangledown$  <sub>PAGE</sub> to select **Delete** and press  $\bullet$  <sub>LAP OK</sub> to enter the history list.
3. Press  $\blacktriangledown$  <sub>PAGE</sub> to select a training history from the list and press  $\bullet$  <sub>LAP OK</sub> to delete the selected history.
4. A "Backup data to web first. Delete?" message appears on the screen. To delete the data, press  $\blacksquare$  <sub>BACK</sub> /  $\blacktriangledown$  <sub>PAGE</sub> to select **Yes** and press  $\bullet$  <sub>LAP OK</sub> to confirm.

## History Flow

trip = Trip Time

09/19	21:44	$\blacktriangledown$
00:03:08	trip	
00:02:25	ride	
3.69	km	
39	kcal	
04	laps	
<b>More</b>	1/20	

Record#/Total records

AVG	MAX	
75.6	75.6	kmh
39	39	bpm
19	19	rpm

The arrow appears only when there is lap in this record.

Lap 01	00:49
0.25	km
81.4	kmh
13	kcal
0	bpm
0	rpm

The arrow appears only when there are more than 1 lap.

# Settings

With the Settings feature, you can customize exercises settings, altitude, general settings, sensor settings, bike and user profiles.

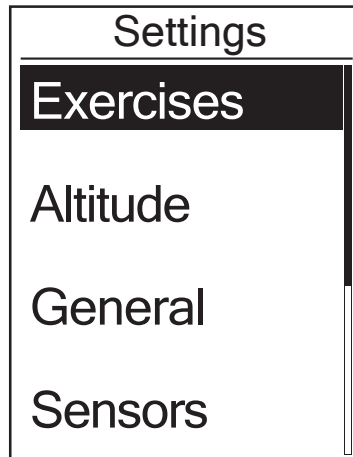

1. In the main screen, press  $\nabla_{PAGE}$  to select **Settings**.
2. Press  $LAP_{OK}$  to enter the Settings menu.

## Smart Lap

With Smart Lap feature, you can use your device to automatically mark the lap at a specific location or after you have traveled a specific distance.

### Lap by Location

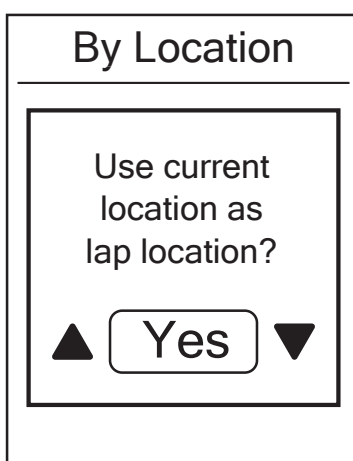

1. In the Settings menu, press  $\nabla_{PAGE}$  to select **Exercises** > **Smart Lap** and press  $LAP_{OK}$ .
2. Press  $LAP_{OK}$  to enter the editing menu.  
Press  $\blacksquare/||_{BACK} / \nabla_{PAGE}$  to select **Location** and press  $LAP_{OK}$  to confirm.
3. A "Use current location as lap location?" message appears on the screen. To save the data, press  $\nabla_{PAGE}$  to select **Yes** and press  $LAP_{OK}$  to confirm.
4. Press  $\blacksquare/||_{BACK}$  to exit this menu.

**NOTE:** If the GPS signal is not fixed, a "No GPS signal. Searching GPS, please wait" message appears on the screen. Check if the GPS is on and make sure you step outside to acquire the signal.

## Lap by Distance

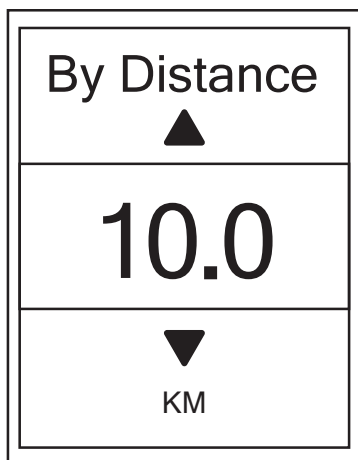

1. In the Settings menu, press  $\nabla_{PAGE}$  to select **Exercise > Smart Lap** and press  $LAP_{OK}$ .
2. Press  $LAP_{OK}$  to enter the editing menu. Press  $\blacksquare/||/\nabla_{BACK/PAGE}$  to select **Distance** and press  $LAP_{OK}$  to confirm.
3. Press  $\blacksquare/||/\nabla_{BACK/PAGE}$  to select your desired distance and press  $LAP_{OK}$  to confirm.
4. Press  $\blacksquare/||_{BACK}$  to exit this menu.

## Altitude

You can set the altitude setting for the current location and four other locations.

### Current Altitude

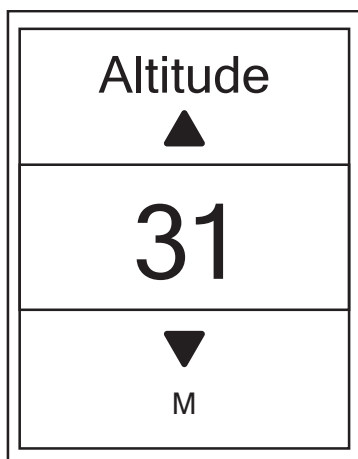

1. In the Settings menu, press  $\nabla_{PAGE}$  to select **Altitude > Altitude** and press  $LAP_{OK}$ .
2. Press  $\blacksquare/||/\nabla_{BACK/PAGE}$  to adjust the desired altitude and press  $LAP_{OK}$  to confirm the setting.
3. Press  $\blacksquare/||_{BACK}$  to exit this menu.



## Other Location Altitude

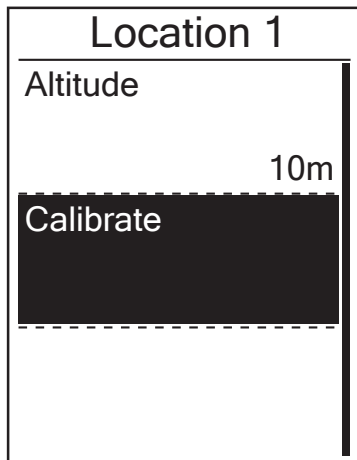

1. In the Settings menu, press  $\nabla_{PAGE}$  to select **Altitude > Location 1, Location 2, Location 3, Location 4, Location 5** and press  $LAP_{OK}$ .
2. To set the altitude, press  $\nabla_{PAGE}$  to select **Altitude** and press  $LAP_{OK}$  to confirm.
3. Press  $\blacksquare/||/\nabla_{PAGE}$  to adjust the desired altitude and press  $LAP_{OK}$  to confirm the setting.
4. To calibrate the set altitude, press  $\nabla_{PAGE}$  to select **Calibrate** and press to  $LAP_{OK}$  confirm.
5. Press  $\blacksquare/||_{BACK}$  to exit this menu.

## Data Page

You can set the display settings for the Meter and Lap.

### Meter Display

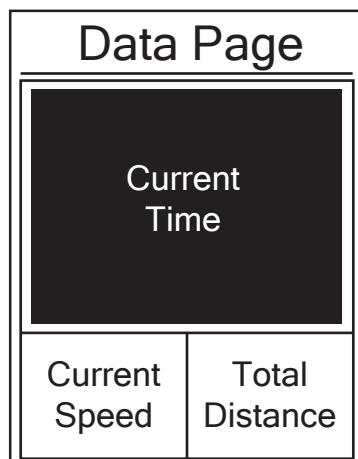

3-grid display

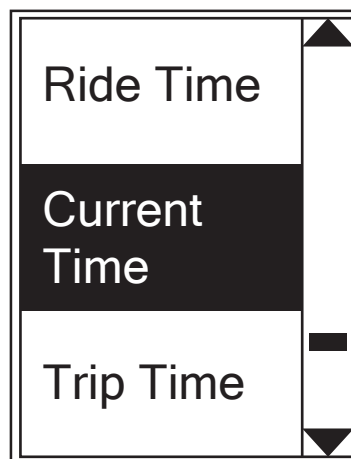

Item selection

1. In the Settings menu, press  $\nabla_{PAGE}$  to select **Exercises > Data Page** and press  $LAP_{OK}$ .
2. Press  $LAP_{OK}$  to enter **Data Page** setting and change the setting from **Auto** to **Manual**.
3. Press  $\nabla_{PAGE}$  to enter **Data Page > Data Page 1, Data Page 2, Data Page 3, Data Page 4** or **Data Page 5** and press  $LAP_{OK}$ .
4. Press  $\blacksquare/||/\nabla_{PAGE}$  to select the number of data fields and press  $LAP_{OK}$  to confirm.

3. Press  $\blacktriangledown$  <sub>PAGE</sub> to select the item field that you want to customize, and press  $\overset{\text{LAP}}{\bullet}$  <sub>OK</sub> to confirm the selection.
4. Press  $\blacksquare$ / $\parallel$ / $\blacktriangledown$  <sub>BACK/PAGE</sub> to select the desired setting and press  $\overset{\text{LAP}}{\bullet}$  <sub>OK</sub> to confirm.
5. Press  $\blacksquare$ / $\parallel$  <sub>BACK</sub> to exit this menu.

**NOTE:** The number of data fields shown on the screen depends on the “Data fields” selection.

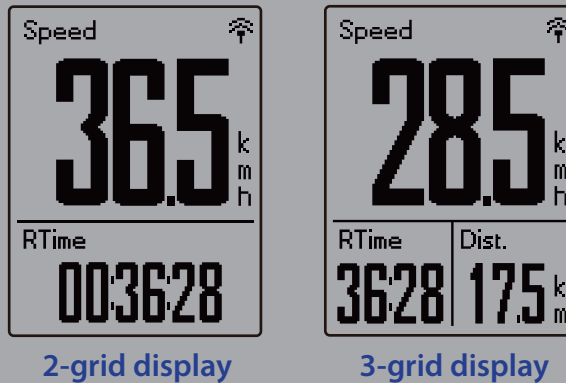

**NOTE:** If Data Page is setted as **Auto**, Rider 100 will automatically adjust its data field display when detecting the paired sensors.

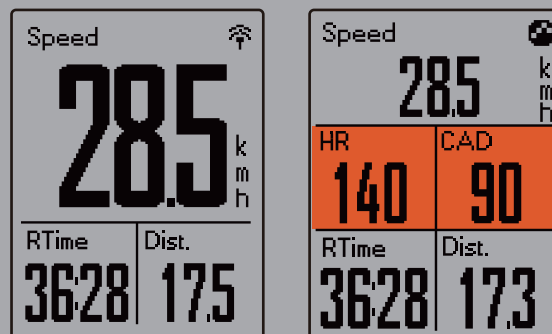

## Lap Display

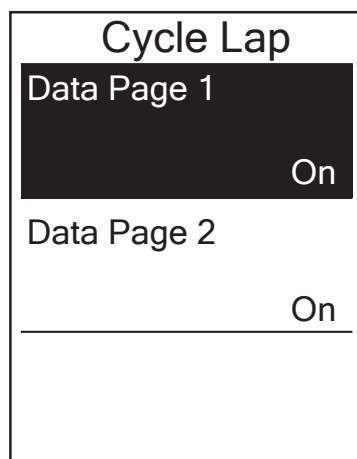

1. In the Settings menu, press  $\blacktriangledown$  <sub>PAGE</sub> to select **Exercises > Data Page > Data Page 1** or **Data Page 2** and press  $\overset{\text{LAP}}{\bullet}$  <sub>OK</sub>.
2. Press  $\blacksquare$ / $\parallel$ / $\blacktriangledown$  <sub>BACK/PAGE</sub> to select the number of data fields and press  $\overset{\text{LAP}}{\bullet}$  <sub>OK</sub> to confirm.
3. Press  $\blacktriangledown$  <sub>PAGE</sub> to select the item field that you want to customize, and press  $\overset{\text{LAP}}{\bullet}$  <sub>OK</sub> to confirm the selection.
4. Press  $\blacksquare$ / $\parallel$ / $\blacktriangledown$  <sub>BACK/PAGE</sub> to select the desired setting and press  $\overset{\text{LAP}}{\bullet}$  <sub>OK</sub> to confirm.
5. Press  $\blacksquare$ / $\parallel$  <sub>BACK</sub> to exit this menu.

## Set Alert

With the Alert feature, the device displays a message to notify you if:

- your heart rate exceeds or drops below a specific number of beats per minute (bpm).
- you exceed or drop below a custom speed setting during your ride.
- your cadence speed exceeds or drops below a specific number of revolutions of the crank arm per minute (rpm).
- you reach a certain amount of distance for the long workouts.
- you reach a certain amount of time for the long workouts.

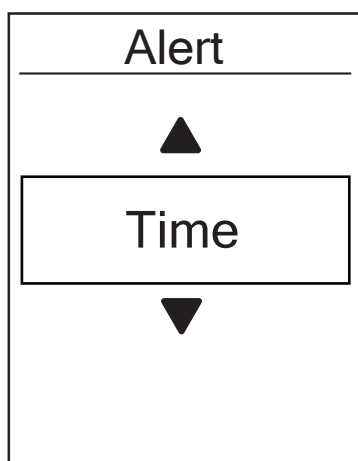

1. In the Settings menu, press  $\blacktriangledown$ <sub>PAGE</sub> to select **Exercises** > **Alert** and press  $\bullet$ <sub>LAP OK</sub> to enter its submenu.
2. Select **Time**, **Distance**, **Speed**, **HR**, or **Cadence** and press  $\bullet$ <sub>LAP OK</sub> to configure the necessary settings.
3. Press  $\blacksquare$ /<sub>BACK</sub> /  $\blacktriangledown$ /<sub>PAGE</sub> to select the desired setting and press  $\bullet$ <sub>LAP OK</sub> to confirm.

## Smart Pause

When you have a lot of obstacles along your route such as traffic lights, crosswalk, etc., this can really impact your recorded data. When the function is activated, the time and distance will automatically pause once you stop moving and resume once you start riding to enhance your data efficiency.

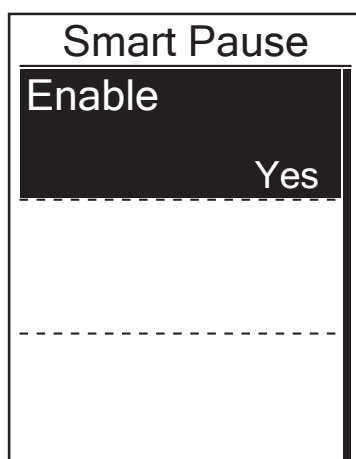

1. In the Settings menu, press  $\blacktriangledown$ <sub>PAGE</sub> to select **Exercises** > **Smart Pause** and press  $\bullet$ <sub>LAP OK</sub> to enter its submenu.
2. Select **Yes** to enable the function.

# Data Record

With Data Record function, you can set your odometer and activate 1 second mode to get more accurate data.

## Set ODO

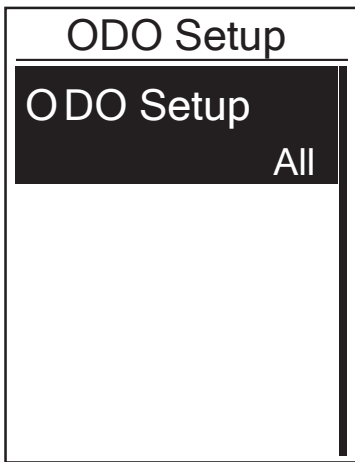

1. In the Settings menu, press  $\blacktriangledown$  <sub>PAGE</sub> to select **Exercise > Data Record** and press  $\bullet$  <sub>LAP OK</sub>.
2. Press  $\blacktriangledown$  <sub>PAGE</sub> to select **ODO Setup** and press  $\bullet$  <sub>LAP OK</sub> to enter.
3. Press  $\bullet$  <sub>LAP OK</sub> to enter its submenu and press  $\blacksquare$  /  $\parallel$  /  $\blacktriangledown$  <sub>BACK / PAGE</sub> to select the desired setting, then press  $\bullet$  <sub>LAP OK</sub> to confirm.

**NOTE:** **All** means the odometer would show the cumulative distance of all trips; **Recorded** would only show the cumulative distance of recorded trips.

## Enable 1sec Mode

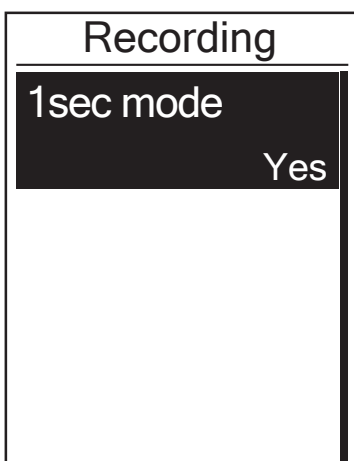

1. In the Settings menu, press  $\blacktriangledown$  <sub>PAGE</sub> to select **Exercise > Data Record** and press  $\bullet$  <sub>LAP OK</sub>.
2. Press  $\blacktriangledown$  <sub>PAGE</sub> to select **Recording** and press  $\bullet$  <sub>LAP OK</sub> to enter.
3. Press  $\bullet$  <sub>LAP OK</sub> to enter its submenu and press  $\blacksquare$  /  $\parallel$  /  $\blacktriangledown$  <sub>BACK / PAGE</sub> to select **Yes**, and press  $\bullet$  <sub>LAP OK</sub> to confirm.
4. Press  $\blacksquare$  /  $\parallel$  <sub>BACK</sub> to exit this menu.

## Personalize User Profile

You can change your personal information.

User	
Gender	Male
Birthday	1982/01/01
Height	177 cm

1. In the Settings menu, press  $\blacktriangledown$  PAGE to select **User** and press  $\bullet$  LAP /  $\bullet$  OK.
2. Press  $\blacktriangledown$  PAGE to select the setting that you want to change and press  $\bullet$  LAP /  $\bullet$  OK to enter its submenu.
  - Gender: select your gender.
  - Birthday : set your Birthday
  - Height: set your height.
  - Weight: set your weight.
  - Max HR: set your maximum heart rate.
  - LTHR: set your lactate threshold heart rate.
  - FTP: set your functional threshold power.
  - MAP: set your maximum aerobic power.
3. Press  $\blacksquare$  /  $\parallel$  /  $\blacktriangledown$  BACK / PAGE to adjust the desired setting and press  $\bullet$  LAP /  $\bullet$  OK to confirm.
4. Press  $\blacksquare$  /  $\parallel$  BACK to exit this menu.

# Personalize Bike Profile

You can customize and view your bicycle(s) profile.

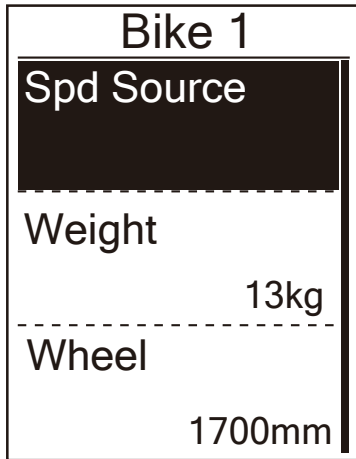

1. In the Settings menu, press  $\blacktriangledown$  <sub>PAGE</sub> to select **Profile > Bike Profile > Bike 1 or Bike 2** and press  $\bullet$  <sub>LAP OK</sub>.
2. Press  $\blacktriangledown$  <sub>PAGE</sub> to select the setting that you want to change and press  $\bullet$  <sub>LAP OK</sub> to enter its submenu.
  - Spd Source: set the priority of the speed sources
  - Weight: set the bike weight.
  - Wheel: set the bike wheel size.
  - Activate: select to activate the bike.
3. Press  $\blacksquare$  /  $\parallel$  /  $\blacktriangledown$  <sub>BACK / PAGE</sub> to adjust the desired setting and press  $\bullet$  <sub>LAP OK</sub> to confirm.
4. Press  $\blacksquare$  /  $\parallel$  <sub>BACK</sub> to exit this menu.

**NOTE:** For details on wheel size, see “Wheel Size and Circumference” on page 36.

## View Bike Profile

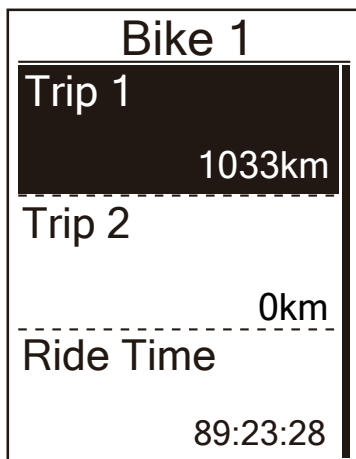

1. In the Settings menu, press  $\blacktriangledown$  <sub>PAGE</sub> to select **Profile > Bike Profile > Overview** and press  $\bullet$  <sub>LAP OK</sub>.
2. Press  $\blacktriangledown$  <sub>PAGE</sub> to select the desired bike and press  $\bullet$  <sub>LAP OK</sub> to confirm.
3. Press  $\blacktriangledown$  <sub>PAGE</sub> to view more data of the selected bike.
4. Press  $\blacksquare$  /  $\parallel$  <sub>BACK</sub> to exit this menu.

## Change System Settings

You can customize the device system settings such as backlight off, key tone, sound, time/unit, on-screen display language.

### Backlight Off

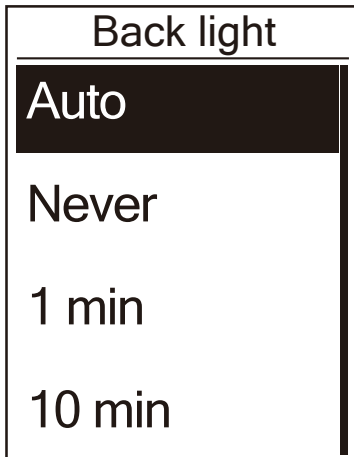

1. In the Settings menu, press  $\blacktriangledown$  <sub>PAGE</sub> to select **General > System > Backlight Off** and press  $\text{LAP} \bullet$  <sub>OK</sub>.
2. Press  $\blacksquare / \parallel / \blacktriangledown$  <sub>BACK / PAGE</sub> to select the desired setting and press  $\text{LAP} \bullet$  <sub>OK</sub> to confirm.
3. Press  $\blacksquare / \parallel$  <sub>BACK</sub> to exit this menu.

### Key Tone

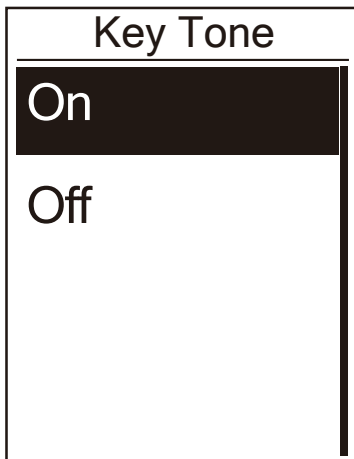

1. In the Settings menu, press  $\blacktriangledown$  <sub>PAGE</sub> to select **General > System > Key Tone** and press  $\text{LAP} \bullet$  <sub>OK</sub>.
2. Press  $\blacksquare / \parallel / \blacktriangledown$  <sub>BACK / PAGE</sub> to select the desired setting and press  $\text{LAP} \bullet$  <sub>OK</sub> to confirm.
3. Press  $\blacksquare / \parallel$  <sub>BACK</sub> to exit this menu.

## Sound

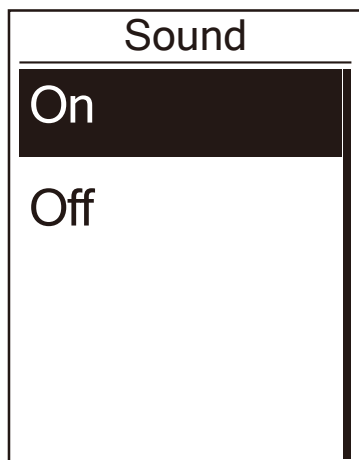

1. In the Settings menu, press  $\blacktriangledown$  <sub>PAGE</sub> to select **General > System > Sound** and press  $\text{LAP} \bullet$  <sub>OK</sub>.
2. Press  $\blacksquare / \parallel$  <sub>BACK / PAGE</sub>  $\blacktriangledown$  to select the desired setting and press  $\text{LAP} \bullet$  <sub>OK</sub> to confirm.
3. Press  $\blacksquare / \parallel$  <sub>BACK</sub> to exit this menu.

## Time/Unit

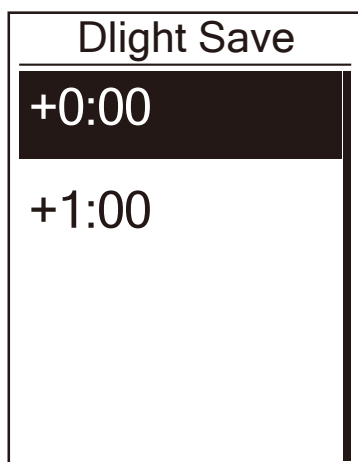

Daylight Save



Date format

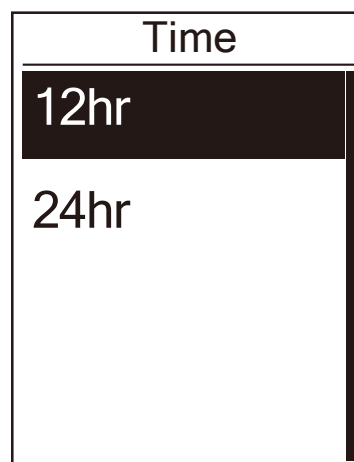

Time format



Unit

1. In the Settings menu, press  $\blacktriangledown$  <sub>PAGE</sub> to select **General > System > Time/Unit > Daylight Save, Date format, Time format, Unit Temperature** and press  $\text{LAP} \bullet$  <sub>OK</sub>.
2. Press  $\blacksquare / \parallel$  <sub>BACK / PAGE</sub>  $\blacktriangledown$  to select the desired setting/format and press  $\text{LAP} \bullet$  <sub>OK</sub> to confirm.
3. Press  $\blacksquare / \parallel$  <sub>BACK</sub> to exit this menu.



## Language



1. In the Settings menu, press  $\blacktriangledown$  <sub>PAGE</sub> to select **General > System > Language** and press  $\bullet$  <sub>LAP OK</sub>.
2. Press  $\blacksquare$ / $\parallel$ / $\blacktriangledown$  <sub>BACK / PAGE</sub> to select the desired setting and press  $\bullet$  <sub>LAP OK</sub> to confirm.
3. Press  $\blacksquare$ / $\parallel$  <sub>BACK</sub> to exit this menu.

## View GPS Status

You can view the GPS signal information that your device is currently receiving.

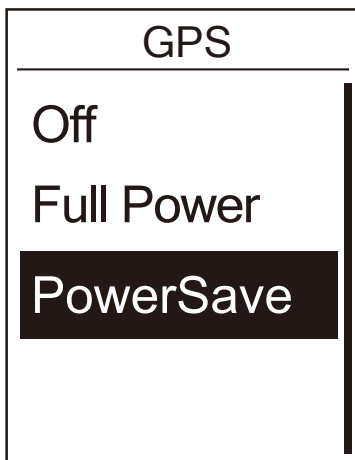

1. In the Settings menu, press  $\blacktriangledown$  <sub>PAGE</sub> to select **General > GPS** and press  $\bullet$  <sub>LAP OK</sub>.
2. To set the signal search mode, press  $\bullet$  <sub>LAP OK</sub> to confirm.
3. Press  $\blacksquare$ / $\parallel$ / $\blacktriangledown$  <sub>BACK / PAGE</sub> to select the desired setting and press  $\bullet$  <sub>LAP OK</sub> to confirm.
  - Off: Turn-off GPS functions. Choose this to save power when GPS signal is not available, or when GPS information is not required (such as indoor use).
  - Full Power: maximum position and speed accuracy, consumes more power.
  - PowerSaving: Achieves longer battery life when used in good GPS signal condition, but less accurate.

## View Software Version

You can view your device current software version.

1. In the Settings menu, press  $\blacktriangledown$  <sub>PAGE</sub> to select **General > About**.
2. Press  $\text{LAP} \bullet$  <sub>OK</sub> to confirm.  
The current software version is displayed on the screen.
3. Press  $\blacksquare / \parallel$  <sub>BACK</sub> to exit this menu.

## Bluetooth

Before pairing Rider 310 with your bluetooth enabled mobile phone, make sure the bluetooth function of your mobile phone and Rider 310 is turned on.

### Enable Bluetooth

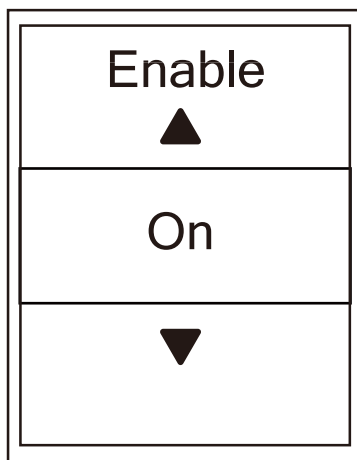

1. In the Settings menu, press  $\blacktriangledown$  <sub>PAGE</sub> to select **General > Bluetooth** and press  $\text{LAP} \bullet$  <sub>OK</sub>.
2. Press  $\blacksquare / \parallel / \blacktriangledown$  <sub>BACK / PAGE</sub> to select **On** and press  $\text{LAP} \bullet$  <sub>OK</sub> to confirm.
3. Press  $\blacksquare / \parallel$  <sub>BACK</sub> to exit this menu.

## Configure Auto Scroll

When the feature is enabled, the data will automatically switch pages at the preset time.

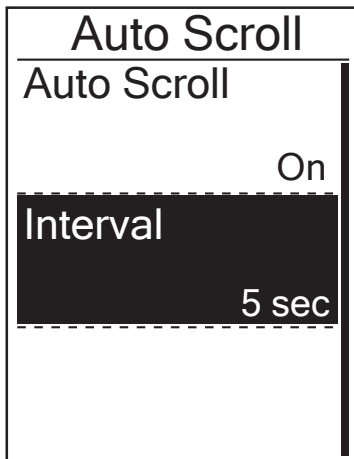

1. In the Settings menu, press  $\blacktriangledown$  <sub>PAGE</sub> to select **General > Auto Scroll** and press  $\overset{\text{LAP}}{\bullet}$  <sub>OK</sub>.
2. Press  $\blacktriangledown$  <sub>PAGE</sub> to select the setting that you want to change and press  $\overset{\text{LAP}}{\bullet}$  <sub>OK</sub> to enter its submenu.
  - Auto scroll: enable/disable the auto switch.
  - Interval: set the interval time.
3. Press  $\blacksquare$ / $\parallel$ / $\blacktriangledown$  <sub>BACK / PAGE</sub> to adjust the desired setting and press  $\overset{\text{LAP}}{\bullet}$  <sub>OK</sub> to confirm.
4. Press  $\blacksquare$ / $\parallel$  <sub>BACK</sub> to exit this menu.

## Enable File Saving Mode

When the feature is enabled, the device will automatically overwrite from your oldest records when memory storage is full.

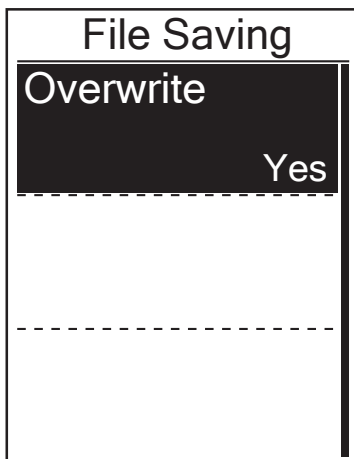

1. In the Settings menu, press  $\blacktriangledown$  <sub>PAGE</sub> to select **General > File Saving** and press  $\overset{\text{LAP}}{\bullet}$  <sub>OK</sub>.
2. Press  $\overset{\text{LAP}}{\bullet}$  <sub>OK</sub> to enter its submenu and press  $\blacksquare$ / $\parallel$ / $\blacktriangledown$  <sub>BACK / PAGE</sub> to adjust the desired setting and press  $\overset{\text{LAP}}{\bullet}$  <sub>OK</sub> to confirm.
3. Press  $\blacksquare$ / $\parallel$  <sub>BACK</sub> to exit this menu.

## Start Reminder

When Rider 310 detects the motion of your bike, it would pop up a reminder to ask you if you would like to record or not. You can set the frequency of start reminder.

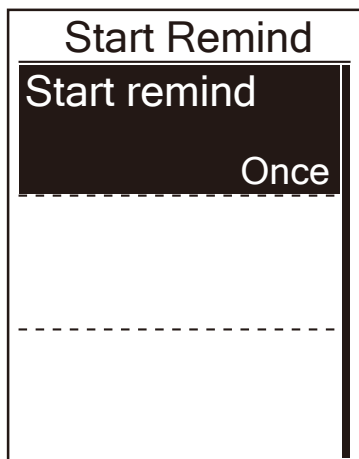

1. In the Settings menu, press  $\blacktriangledown$  <sub>PAGE</sub> to select **General > Start Remind** and press  $\bullet$  <sub>LAP</sub> <sub>OK</sub>.
2. Press  $\bullet$  <sub>LAP</sub> <sub>OK</sub> to enter its submenu and press  $\blacksquare$  /  $\parallel$  /  $\blacktriangledown$  <sub>BACK</sub> / <sub>PAGE</sub> to adjust the desired setting and press  $\bullet$  <sub>LAP</sub> <sub>OK</sub> to confirm.
3. Press  $\blacksquare$  /  $\parallel$  <sub>BACK</sub> to exit this menu.

## View Memory Usage

View the storage status of the device.

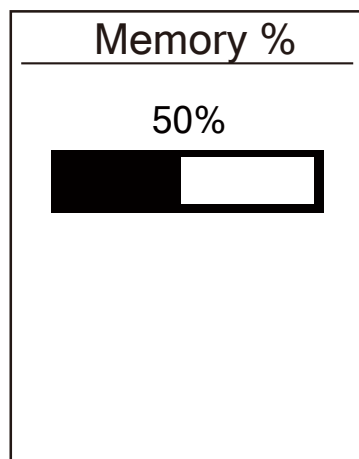

1. In the Settings menu, press  $\blacktriangledown$  <sub>PAGE</sub> to select **General > Memory %** and press  $\bullet$  <sub>LAP</sub> <sub>OK</sub>.  
The storage status is displayed on the screen.
2. Press  $\blacksquare$  /  $\parallel$  <sub>BACK</sub> to exit this menu.

# Reset Data

You can resotre your Rider 310 to factory setting.

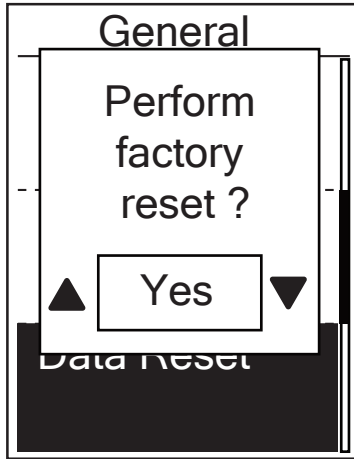

1. In the Settings menu, press  $\blacktriangledown$  PAGE to select **General > Data Reset** and press  $\bullet$  LAP OK.
2. Press  $\blacksquare$  BACK /  $\blacktriangledown$  PAGE to adjust the desired setting and press  $\bullet$  LAP OK to confirm.

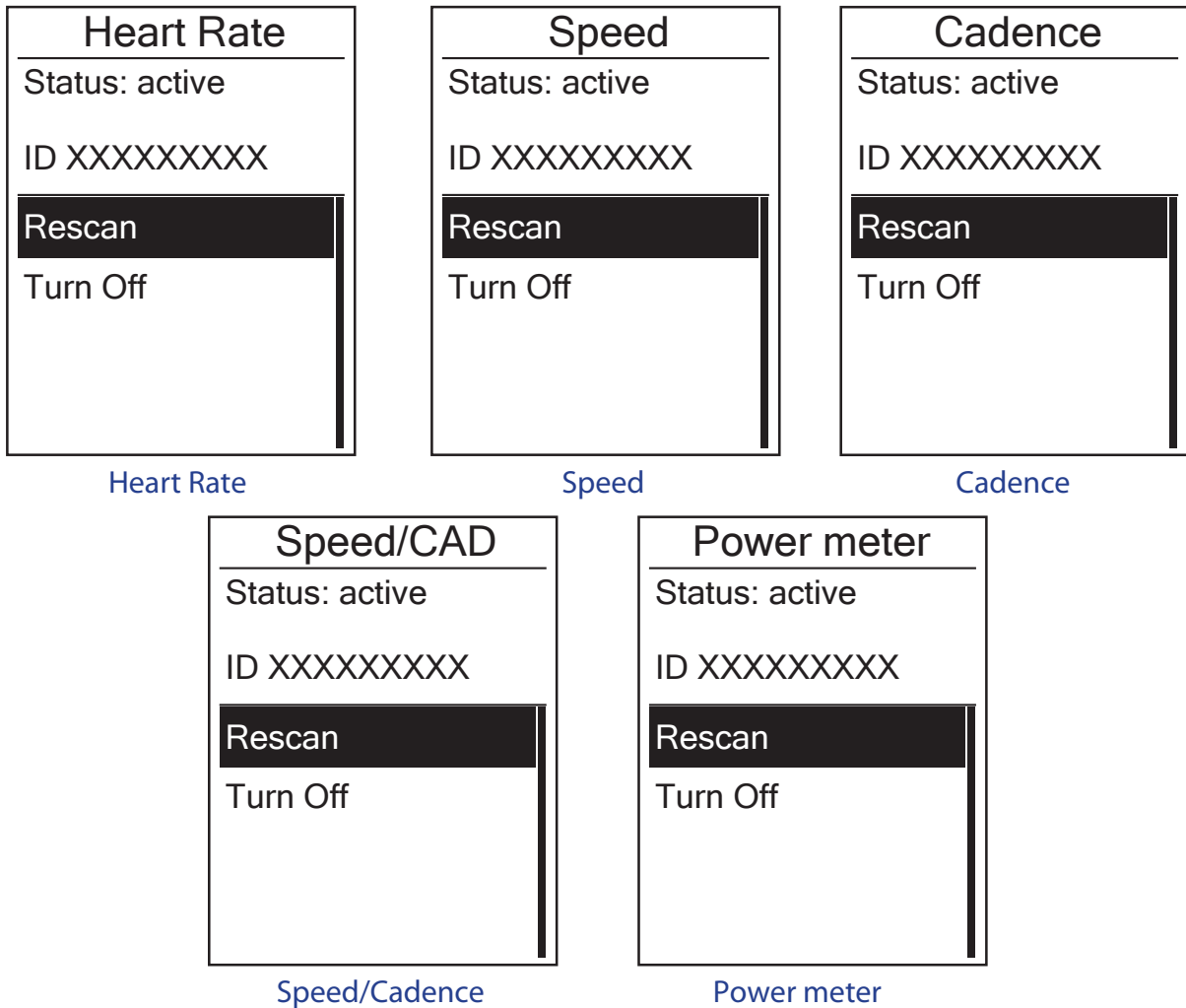

# Sensors

You can customize the respective sensor settings such as enable/disable the function or rescan the sensor for the device.



1. In the Settings menu, press  $\blacktriangledown$  PAGE to select **Sensors > Heart Rate, Speed, Cadence, or Speed/CAD Power Meter** and press  $\bullet$  LAP OK.
2. Press  $\bullet$  LAP OK to have more options. Press  $\blacktriangledown$  PAGE to select the desired setting and press  $\bullet$  LAP OK to confirm.
  - Rescan: rescan to detect the sensor.
  - Turn on/Turn off: enable/disable the sensor.
3. Press  $\blacksquare$  /|| BACK to exit this menu.

## NOTE:

- When the heart rate monitor is paired, the  heart rate icon appears on the main screen. While pairing your speed/cadence sensor/the heart rate belt and power meter, please make sure there is no other cadence/speed sensor/power meter within 5 m. When the cadence sensor is paired, the cadence sensor icon  appears on the main screen.

# Appendix

## Specifications

### Rider 310

Item	Description
Display	1.8" FSTN positive transreflective dot-matrix LCD
Physical Size	45.1 x 69.5 x 17.3 mm
Weight	56g
Operating Temperature	-10°C ~ 50°C
Battery Charging Temperature	0°C ~ 40°C
Battery	Li polymer rechargeable battery
Battery Life	36 hours with open sky
RF Transceiver	2.4GMHz receiver with embedded antenna to support ANT+ heart rate, speed sensor, cadence sensor
GPS	Integrated high-sensitivity GPS receiver with embedded antenna
BLE Smart	Bluetooth smart wireless technology with embedded antenna
Water Resistant	IPX7 waterproof rating

### Cadence Sensor

Item	Description
Physical size	33.9 x 13.5 x 39 mm
Weight	14 g
Water Resistance	IPX7
Transmission range	5 m
Battery life	1 hour per day for 16 months
Operating temperature	-10°C ~ 60°C
Radio frequency/protocol	2.4GHz / Dynastream ANT+ Sport wireless communications protocol

Accuracy may be degraded by poor sensor contact, electrical interference, and receiver distance from the transmitter.

# Heart Rate Monitor

Item	Description
Physical size	67~100 x 26 x 15 mm
Weight	14 g (sensor) / 35g (strap)
Water Resistance	20 m
Transmission range	5 m
Battery life	1 hour per day for 24 months
Operating temperature	5°C ~ 40°C
Radio frequency/protocol	2.4GHz / Dynastream ANT+ Sport wireless communications protocol

Accuracy may be degraded by poor sensor contact, electrical interference, and receiver distance from the transmitter.

## Battery Information

### Heart Rate Monitor and Cadence Sensor Battery

The heart rate monitor/cadence sensor contains a user-replaceable CR2032 battery.

To replace the battery:

1. Locate the circular battery cover on the back of the heart rate monitor/cadence sensor.
2. Use a coin to twist the cover counter-clockwise so the arrow on the cover points to OPEN.
3. Remove the cover and battery. Wait for 30 seconds.
4. Insert the new battery, with the positive connector first into the battery chamber.
5. Use a coin to twist the cover clockwise so the arrow on the cover points to CLOSE.

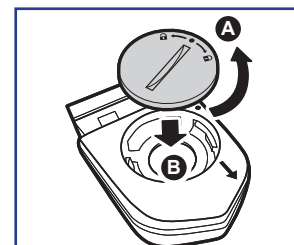
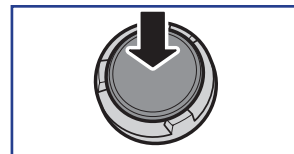
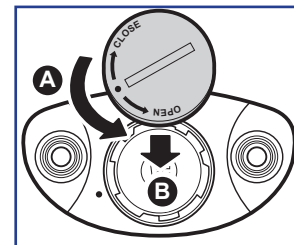

#### NOTE:

- When installing a new battery, if the battery is not placed with the positive connector first, the positive connector will easily deform and malfunction.
- Be careful not to damage or lose the O-ring gasket on the cover.
- Contact your local waste disposal department to properly dispose of used batteries.



## Install Rider 310

### Mount Rider 310 to the Bike

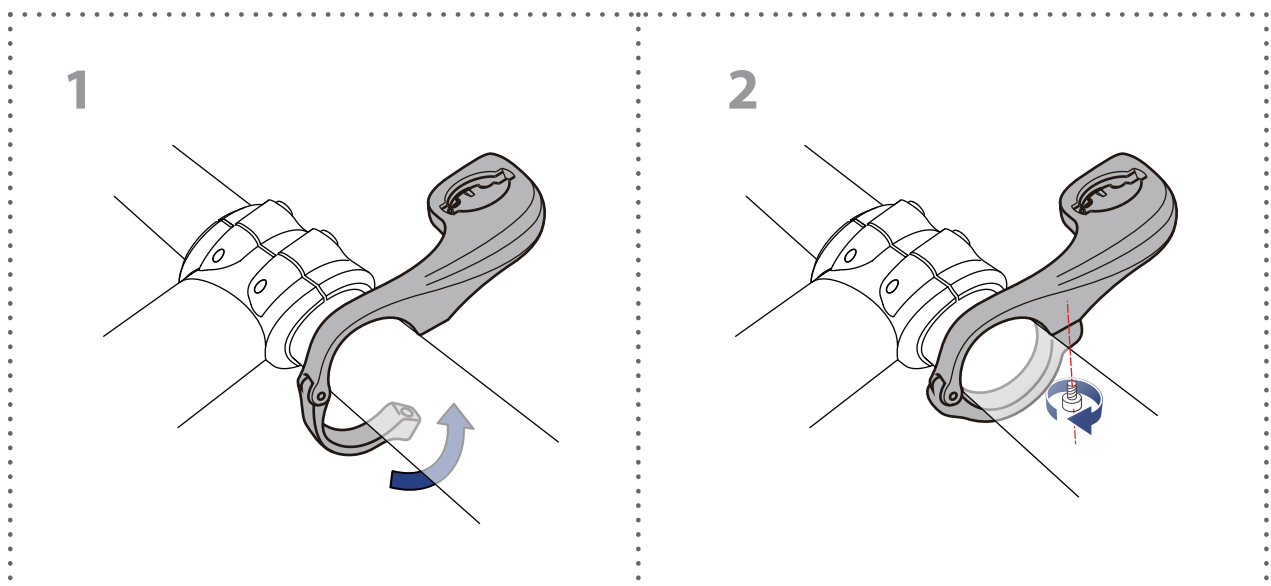
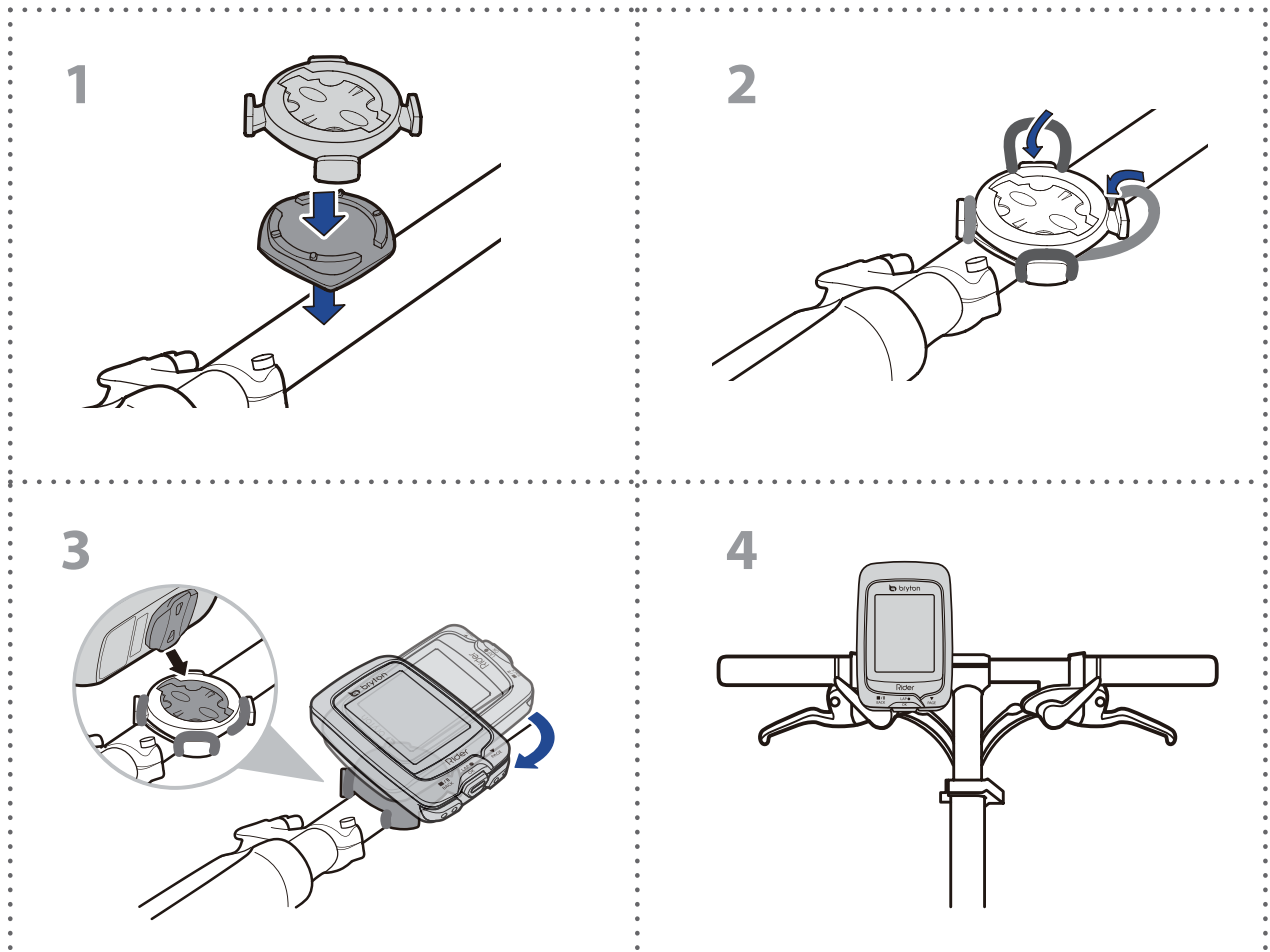

# Install the Speed/Cadence/Dual Sensor (Optional)

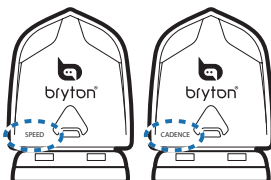
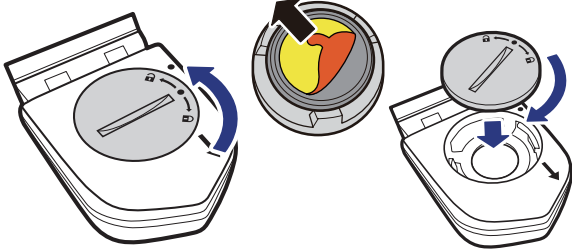
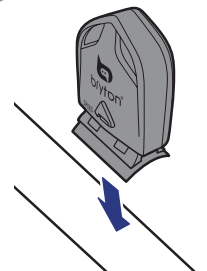
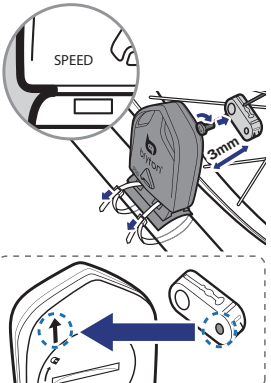
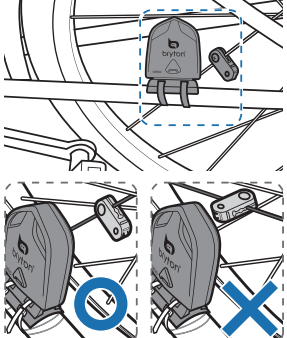
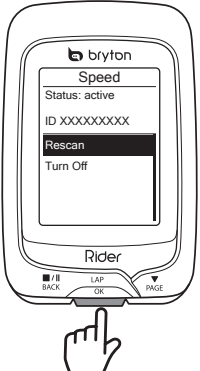
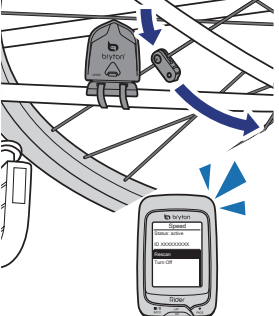
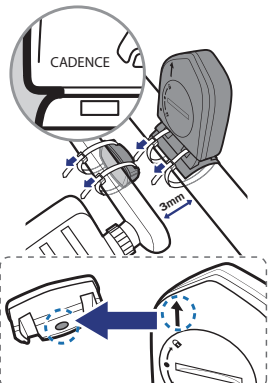
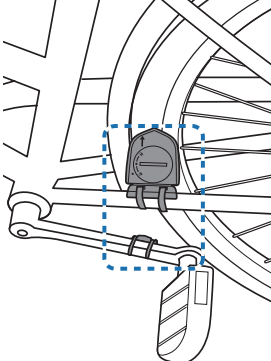
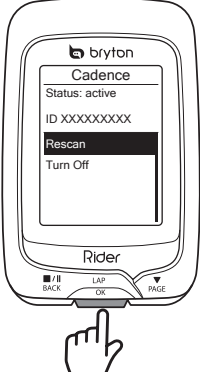
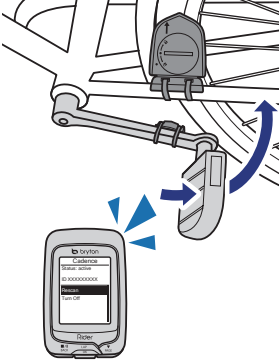
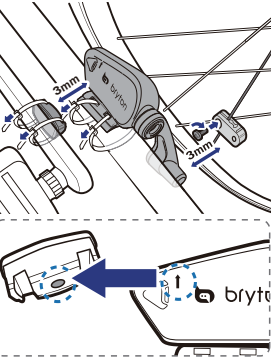
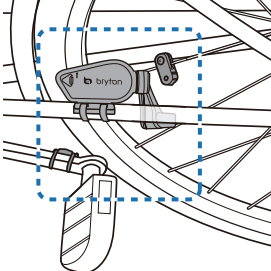
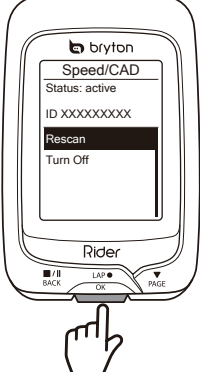
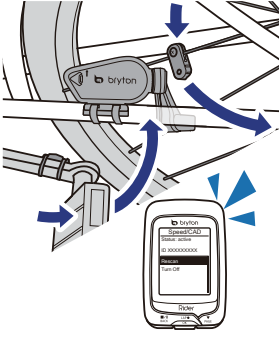
<p><b>1</b></p> 	<p><b>2</b> Remove battery tab before use</p> 	<p><b>3</b></p> 	
<p><b>4a</b></p> 	<p><b>5a</b></p> 	<p><b>6a</b></p> 	<p><b>7a</b></p> 
<p><b>4b</b></p> 	<p><b>5b</b></p> 	<p><b>6b</b></p> 	<p><b>7b</b></p> 
<p><b>4c</b></p> 	<p><b>5c</b></p> 	<p><b>6c</b></p> 	<p><b>7c</b></p> 

**NOTE:**

- To ensure optimum performance, do the following:
  - Align both sensor and magnet as shown in the illustration (5a / 5b). Pay attention on the alignment points.
  - Ensure the distance between the sensor and the magnet is within 3 mm.
- Ensure that both Speed sensor and Speed magnet are installed and aligned horizontally, not vertically.
- On the initial usage, press the front button to activate the sensor and start pedaling. When the sensor detects the magnet, the LED blinks once to indicate the alignment is correct (the LED blinks only for the first ten passes after pressing the button).

## Install Heart Rate Belt (Optional)

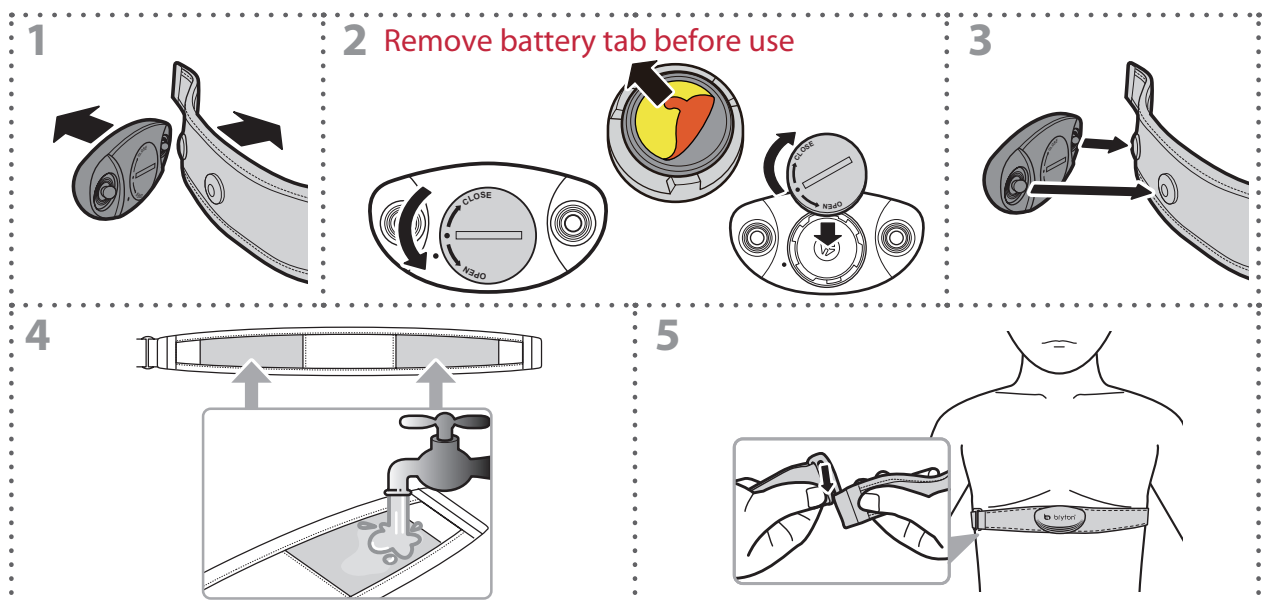
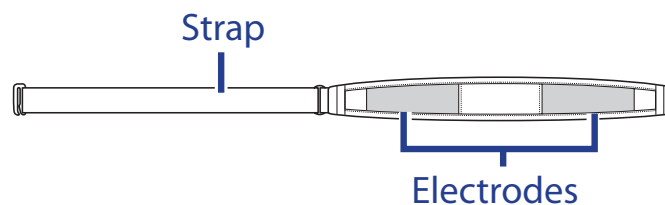
**NOTE:**

- In cold weather, wear appropriate clothing to keep the heart rate belt warm.
- The belt should be worn directly on your body.
- Adjust the sensor position to the middle part of the body (wear it slightly below the chest). The Bryton logo shown on the sensor should be facing upward. Tighten the elastic belt firmly so that it will not turn loose during the exercise.
- If the sensor cannot be detected or the reading is abnormal, please warm up for about 5 minutes.
- If the heart rate belt is not used for a period of time, remove the sensor from the heart rate belt.

# Wheel Size and Circumference

The wheel size is marked on both sides of the tires.

Wheel Size	L(mm)
12x1.75	935
12x1.95	940
14x1.50	1020
14x1.75	1055
16x1.50	1185
16x1.75	1195
16x2.00	1245
16x1-1/8	1290
16x1-3/8	1300
17x1-1/4	1340
18x1.50	1340
18x1.75	1350
20x1.25	1450
20x1.35	1460
20x1.50	1490
20x1.75	1515
20x1.95	1565
20x1-1/8	1545
20x1-3/8	1615
22x1-3/8	1770
22x1-1/2	1785
24x1.75	1890
24x2.00	1925
24x2.125	1965
24x1(520)	1753
24x3/4 Tubular	1785
24x1-1/8	1795
24x1-1/4	1905
26x1(559)	1913
26x1.25	1950
26x1.40	2005
26x1.50	2010
26x1.75	2023
26x1.95	2050
26x2.10	2068
26x2.125	2070
26x2.35	2083

Wheel Size	L(mm)
26x3.00	2170
26x1-1/8	1970
26x1-3/8	2068
26x1-1/2	2100
650C Tubular 26x7/8	1920
650x20C	1938
650x23C	1944
650x25C 26x1(571)	1952
650x38A	2125
650x38B	2105
27x1(630)	2145
27x1-1/8	2155
27x1-1/4	2161
27x1-3/8	2169
27.5x1.50	2079
27.5x2.1	2148
27.5x2.25	2182
700x18C	2070
700x19C	2080
700x20C	2086
700x23C	2096
700x25C	2105
700x28C	2136
700x30C	2146
700x32C	2155
700C Tubular	2130
700x35C	2168
700x38C	2180
700x40C	2200
700x42C	2224
700x44C	2235
700x45C	2242
700x47C	2268
29x2.1	2288
29x2.2	2298
29x2.3	2326

## Basic Care For Your Rider 310

Taking good care of your device will reduce the risk of damage to your device.

- Do not drop your device or subject it to severe shock.
- Do not expose your device to extreme temperatures and excessive moisture.
- The screen surface can easily be scratched. Use the non-adhesive generic screen protectors to help protect the screen from minor scratches.
- Use diluted neutral detergent on a soft cloth to clean your device.
- Do not attempt to disassemble, repair, or make any modifications to your device. Any attempt to do so will make the warranty invalid.

**NOTE:** Improper battery replacement may cause an explosion. When replacing a new battery, use only the original battery or a similar type of battery specified by the manufacturer. Disposal of the used batteries must be carried out in accordance to the regulations of your local authority.



For better environmental protection, waste batteries should be collected separately for recycling or special disposal.

# Data Fields

Data Field	Complete Data Field Name
Sunrise	Sunrise Time
Sunset	Sunset Time
RTime	Ride Time
AvgSpd	Average Speed
Max Spd	Maximum Speed
HR	Heart Rate
Avg HR	Average Heart Rate
Max HR	Maximum Heart Rate
MHR Zone	Maximum Heart Rate Zone
LTHR Zone	Lactate Threshold Heart Rate Zone
MHR%	Maximum Heart Rate Percentage
LTHR%	Lactate Threshold Heart Rate Percentage
AvgCAD	Average Cadence
MaxCAD	Maximum Cadence
LapAvSpd	Lap Average Speed
LapMaSpd	Lap Maximum Speed
L'stLpAvSp	Last Lap Average Speed
LapDist	Lap Distance
L'stLpDist	Last Lap Distance
L'stLapT	Last Lap Time
LapAvHR	Lap Average Heart Rate
LapMaHR	Lap Maximum Heart Rate
L'LpAvHR	Last Lap Average Heart Rate
L'A'MHR%	Lap Average MHR Percentage
L'A'LTHR%	Lap Average LTHR Percentage
LpAvSt'dR	Lap Average Stride Rate
LpStr'dAvL	Lap Stride Average Length
LLpSt'dAvL	Last Lap Stride Average Length
LapAvP	Lap Average Pace
L'stLpAvP	Last Lap Average Pace

Data Fields	Complete Data Field Name
LapMaP	Lap Maximum Pace
LAvCAD	Lap Average Cadence
LLAvCad	Last Lap Average Cadence
ODO	Odometer
Temp.	Temperature
Dist.	Distance
T to Dest	Time to Destination
D to Dest	Distance to Destination
Max Alt.	Maximum Altitude
Alt. Gain	Altitude Gain
Alt. Loss	Altitude Loss
Str'dRate	Stride Rate
AvStr'dRt	Average Stride Rate
MaStr'dRt	Maximum Stride Rate
AvSt'dl'gth	Average Stride Length
AvgPace	Average Pace
MaxPace	Maximum Pace
L'st1kmP	Last 1 km/mile Pace
PW now	Current Power
Avg PW	Average Power
Max PW	Maximum Power
LapMaxPW	Lap Maximum Power
LLapMaxPW	Last Lap Maximum Power
LapAvgPW	Lap Average Power
LLapAvgPW	Last Lap Average Power
3s PW	3 Seconds Average Power
30s PW	30 Seconds Average Power
MAP Zone	Maximum Aerobic Power Zone
MAP%	Maximum Aerobic Power Percentage
FTP Zone	Functional Threshold Power Zone
FTP%	Functional Threshold Power Percentage

Data Fields	Complete Data Field Name
CPB-LR	Current Left and Right Power Balance
MPB-LR	Maximum Left and Right Power Balance
APB L-R	Average Left and Right Power Balance
CTE-LR	Current Left and Right Torque Effectiveness
MTE-LR	Maximum Left and Right Torque Effectiveness
ATE-LR	Average Left and Right Torque Effectiveness
CPS L-R	Current Left and Right Pedal Smoothness
APS L-R	Average Left and Right Pedal Smoothness
MPS-LR	Maximum Left and Right Pedal Smoothness
IF	Intensity Factor
NP	Normalized Power
SP	Specific Power
TSS	Training Stress Score

**NOTE:** Some data fields may only apply to certain models.